

# WILDING WALLBEDS SIDE MOUNT INSTALLATION INSTRUCTION

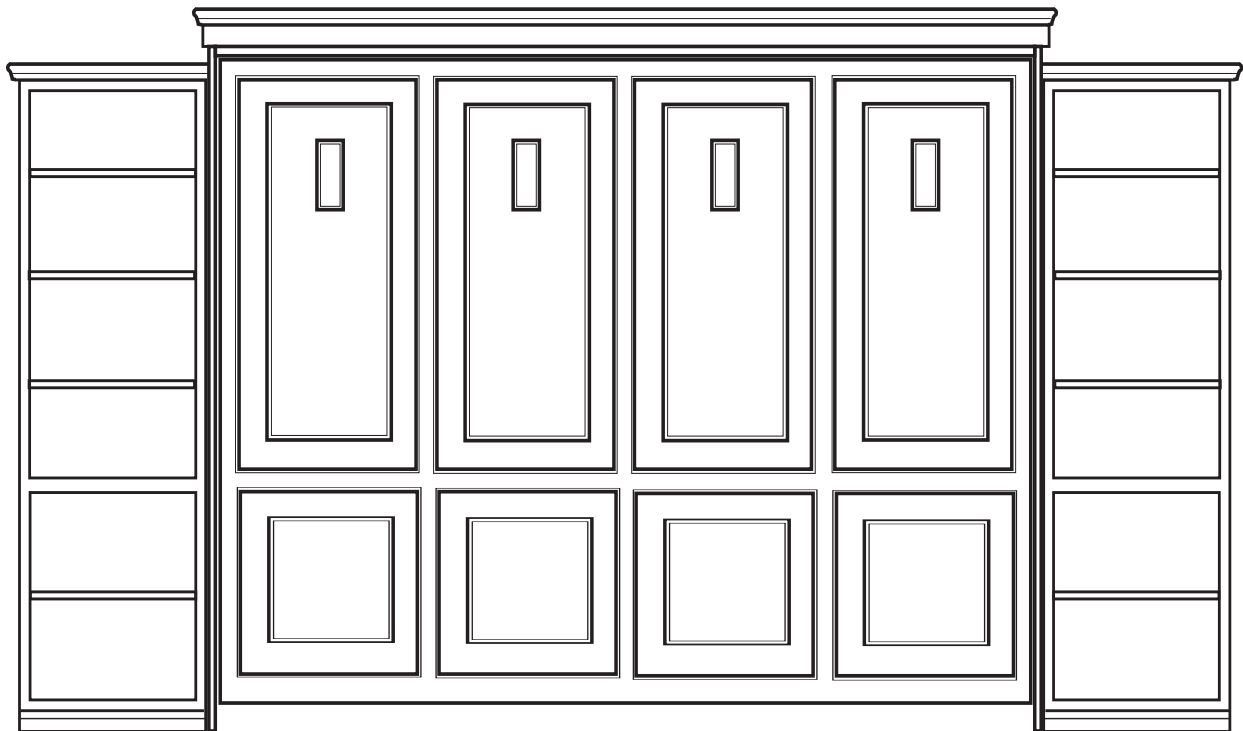



Bed with lights

Booklet 16

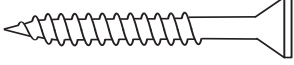

WARNING! ALL MURPY/WALLBED SYSTEMS CONTAIN POWERFUL LIFTING COMPONENTS . FAILURE TO USE AND FOLLOW THESE INSTRUCTIONS DURING THE INSTALLATION PROCESS COULD RESULT IN SEVERE PERSONAL INJURY TO USER OR DAMAGE TO PRODUCT. PLEASE CONTACT CUSTOMER SERVICE AT 866-725-6401 FOR ANY QUESTIONS.

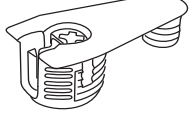
# Hardware Supplied

QTY	SIZE	
3	3 1/2" Grabber	
6	1 1/2" Grabber	
3	Decorative Washer	
3	Cam Fitting (extras)	
3	Connecting Bolt (extras)	

# Tools Needed

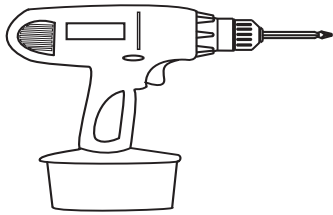

Cordless Screw Driver  
or Power Drill with Phillips bit

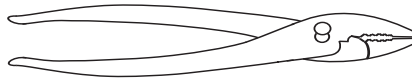

Pliers

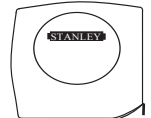

Tape Measure

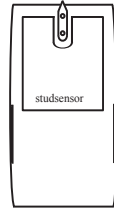

Stud Sensor



Small Regular Screw Driver



Phillips Screw Driver



1/4" wood drill bit

# Wall Bed Components

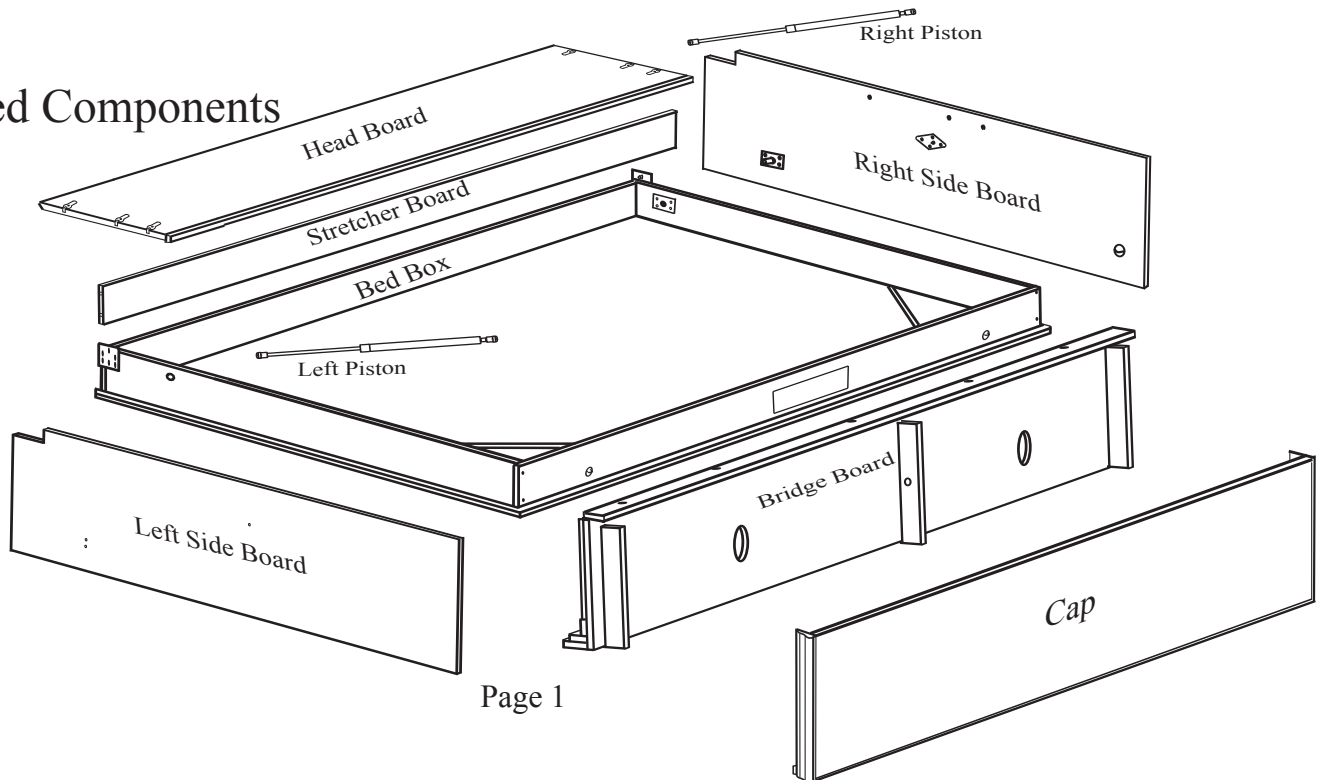

**Step 1:** Position Bed Box and Right and Left Side Boards in your room with the bottom of the bed closest to the wall the bed is to be installed against. (Illustration 1)

**CAUTION:** If your floor is hardwood, tile, or any other hard type flooring, place a blanket down first to protect the bed front from scratches.

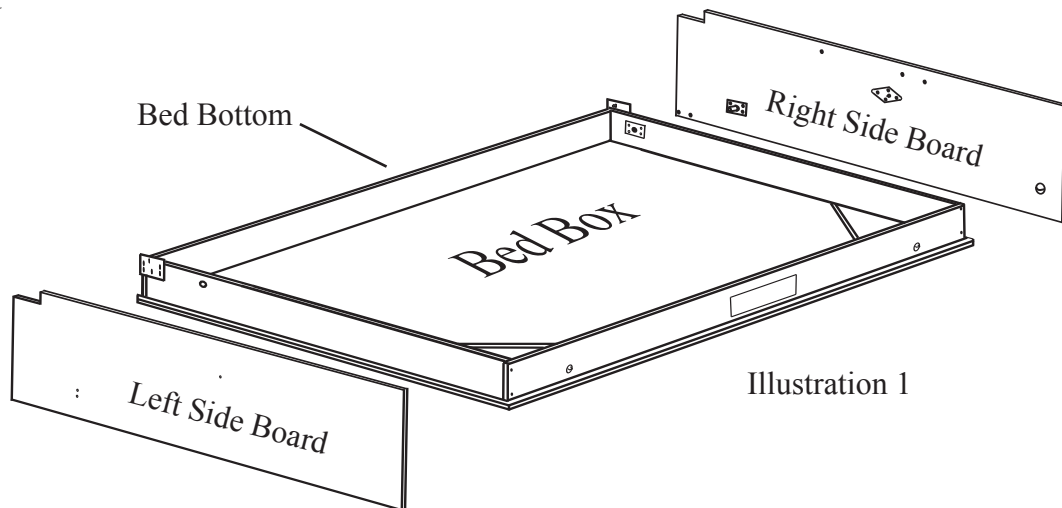
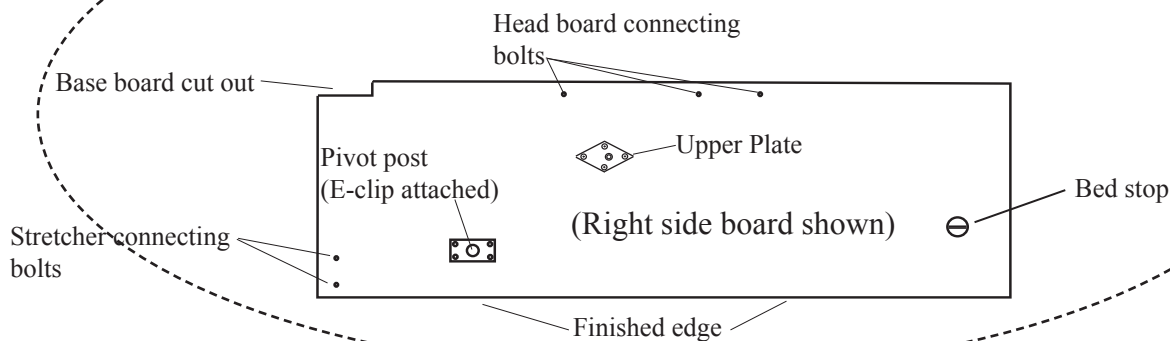

Illustration 1

### Side Board Illustration

For ease of assembly, familiarize yourself with side board parts below.



**Step 2:** With a pair of pliers, or a small regular screw driver, remove the E-clips from pivot posts on the Side Boards. Leave the white nylon spacers in place on the Pivot Posts.

**Step 3:** Slide Side Board Pivot Posts through the Pivot Holes in the bed box as shown. (Illustration 2) Then replace the E-clips by snapping them back onto the Pivot Posts in groove provided.

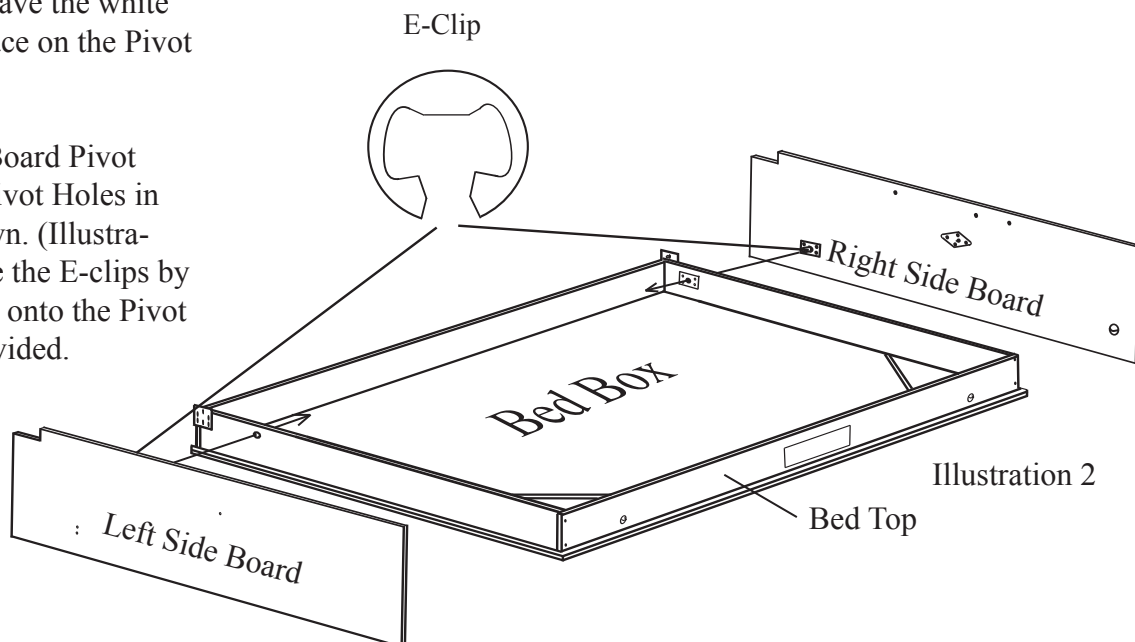

Illustration 2

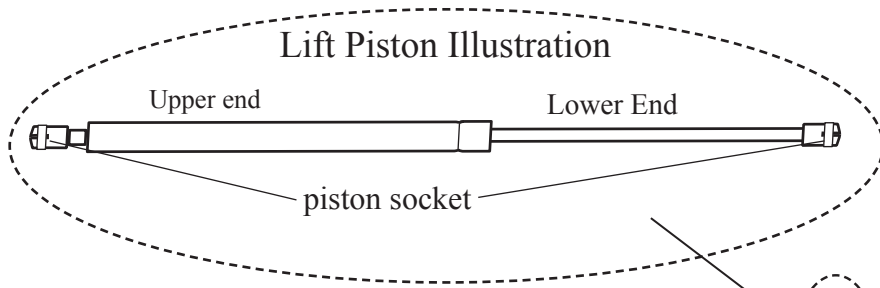
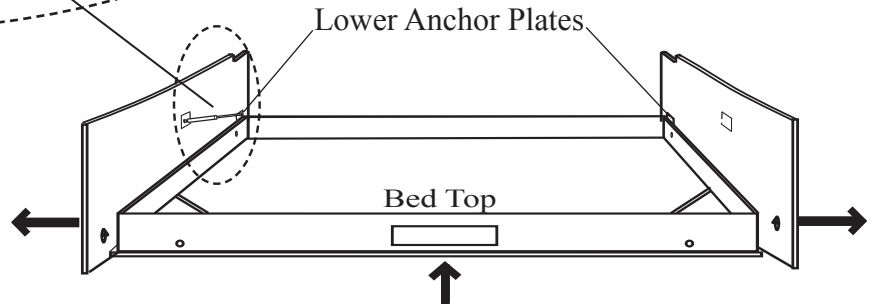

Illustration 3

**Step 4:** Attach the lower end of the LIFT PISTON (skinnier end) onto the LOWER ANCHOR PLATE on both sides of the bed box by positioning the socket end of the piston directly over the anchor ball on the anchor plates and pushing them on. The piston socket should snap into place over the anchor ball.



**Step 5:** Spread out the Side Board tops so the Bed Box has clearance to pass through the brass bed stops on the Side Boards (illustration 3).

**Step 6:** This step will require two people. One person will need to kneel down in front of the Bed Box and lift it up about 5 to 7 inches. The second person will position the upper socket end of the LIFT PISTON directly over the anchor ball on the upper anchor plate and snap it into place. The first person may need to raise and lower the Bed Box slightly to allow the piston to snap on. Repeat step 6 for the opposite piston to be snapped into place.

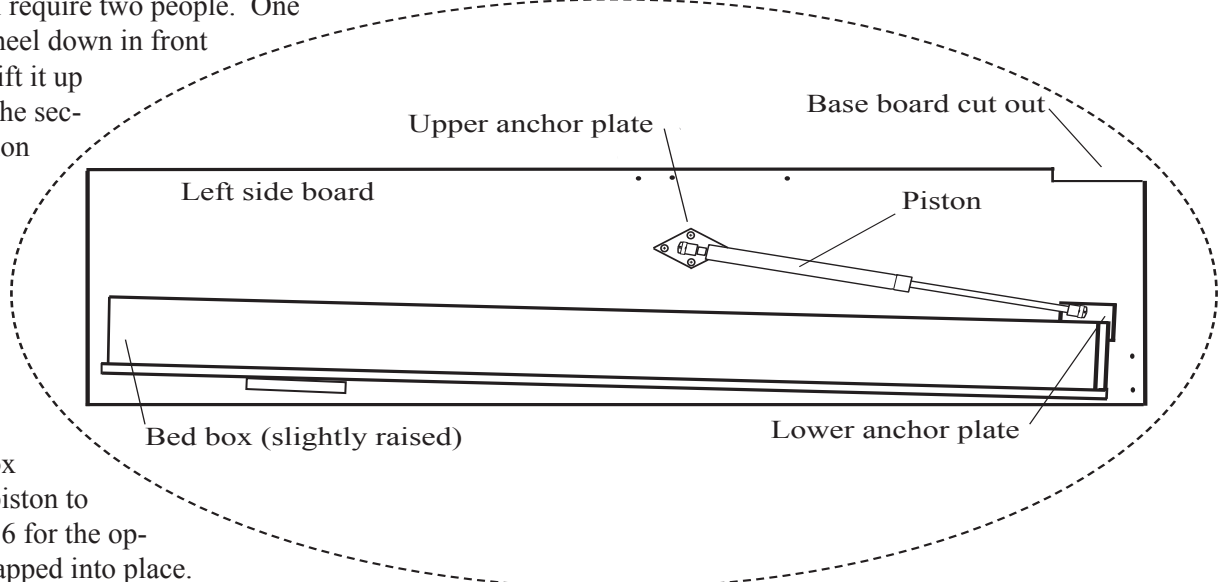

**Step 7:** With the Bed still laying face down the Headboard can be installed. **HAVE SOMEONE HELP WITH THIS STEP.** Line up one side of the Headboard's Cam Fittings with the Connecting Bolts on the Side Board and hold it in place while the second person gently pulls out ward on the opposite Side Board until the Headboard will pass the other set of Connecting Bolts. Make sure the unfinished side of the Headboard is facing up, or that you are looking at the unfinished side of the Head Board as you position it. Now with a Phillips screw driver tighten the Cam Fittings by turning them clockwise. Do this procedure by hand **DO NOT USE A POWER SCREW DRIVER.** (See illustration 4)

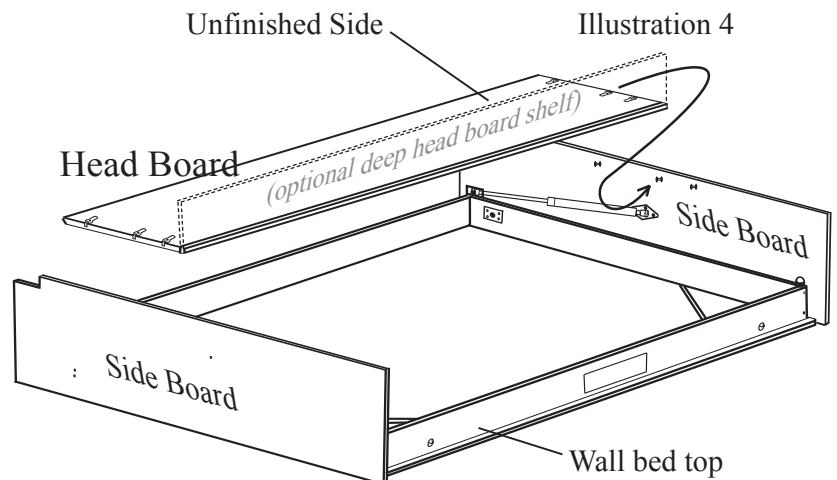

Step 8: Once the Head Board is attached to the Side Boards place the Brass Bed Bumpers onto the Bed Rail on both sides of the bed box. (See Illustration 5)

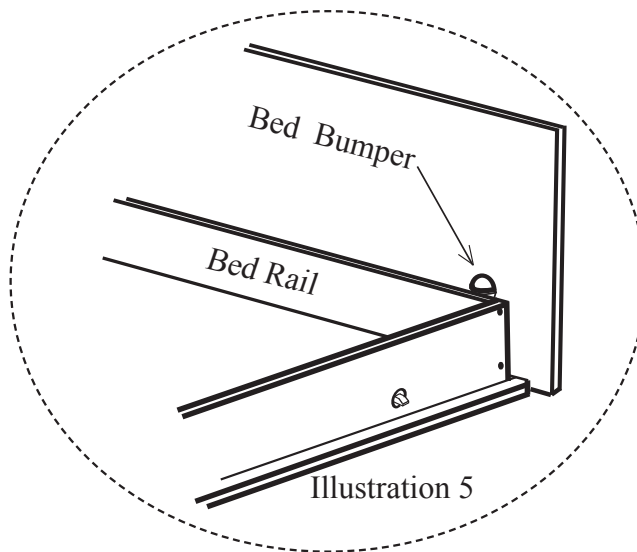
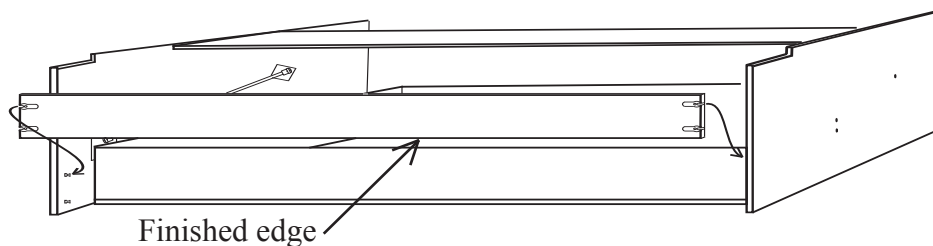

Illustration 7

Step 9: Locate the Stretcher Board and slide it between the Side Boards at the bottom of the Wallbed. Insert the Connecting Bolts into the Cam fittings and tighten them by turning the cam clockwise. Do this procedure by hand DO NOT USE A POWER SCREW DRIVER. (See illustration 7)



**IMPORTANT NOTE!** Position the Stretcher so the 3/4" finished edge is DOWN toward your floor.

Step 10: Have someone help lift the Wall Bed into the standing position. Leave it about 2 feet from the wall the bed is to be installed against so there will be room to work behind the bed.

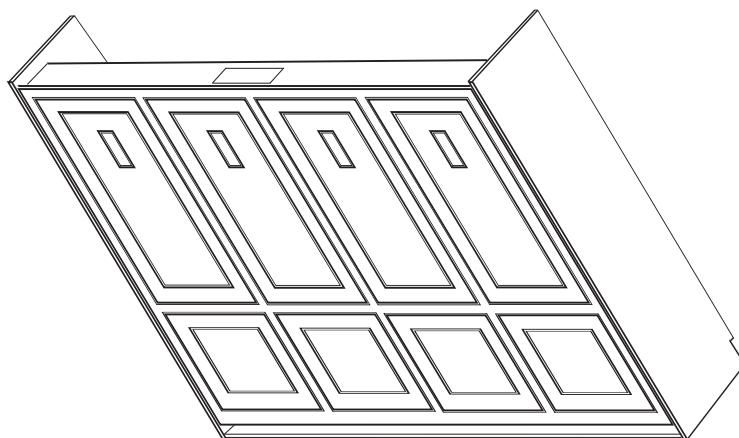

**Step 11:** Place the Bridge Board on top of the Wall Bed and position it so the front of the Bridge is flush with the front of the Side Boards.

Helpful Hint: The Bridge Board has holes for lights

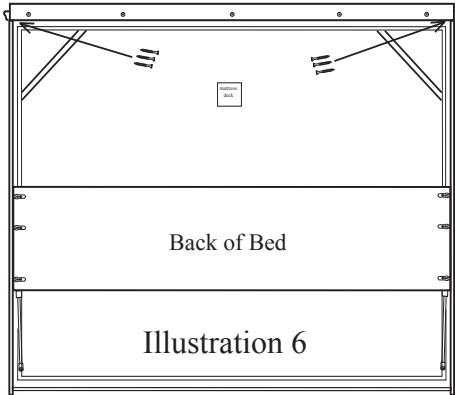
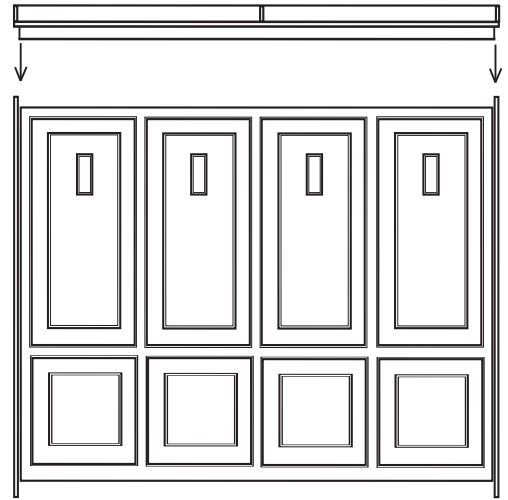

**Step 12:** From the back of the Wall Bed attach the Bridge to the Side Boards using three (on each side) 1 1/2" screws. Place the screws through the holes provided in the corner blocks on the Bridge Board and drive them into the Side Boards. (See illustration 6)



IF YOU PURCHASED LIGHTS FOR YOU WALLBED YOU MUST REFER TO THE LIGHT KIT INSTRUCTIONS AND INSTALL THE LIGHT KIT BEFORE MOVING ON.  
(Light Kit instructions are in the Light Kit box)

**Step 13:** Once the bed is standing up, slide it back and position it against the wall where it is to be installed. Check the gap between the Side Boards and the Bed Box on both sides. The gap at this point will probably need to be adjusted. You can adjust the gap by pushing the bed to one side or the other at the top of the bed. Pushing it will even the gap from top to bottom on each side. At this point don't worry if one side has a larger gap than the other as long as each sides gap is about the same from top to bottom on each side. (See illustration 7)

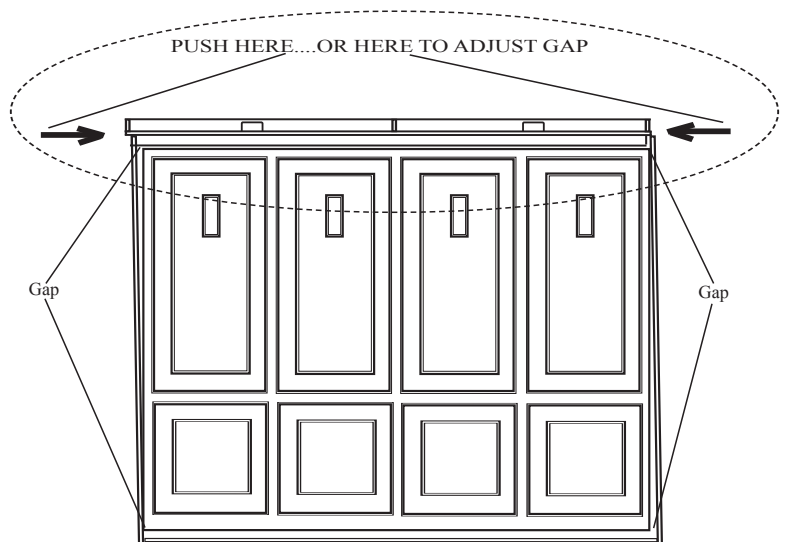
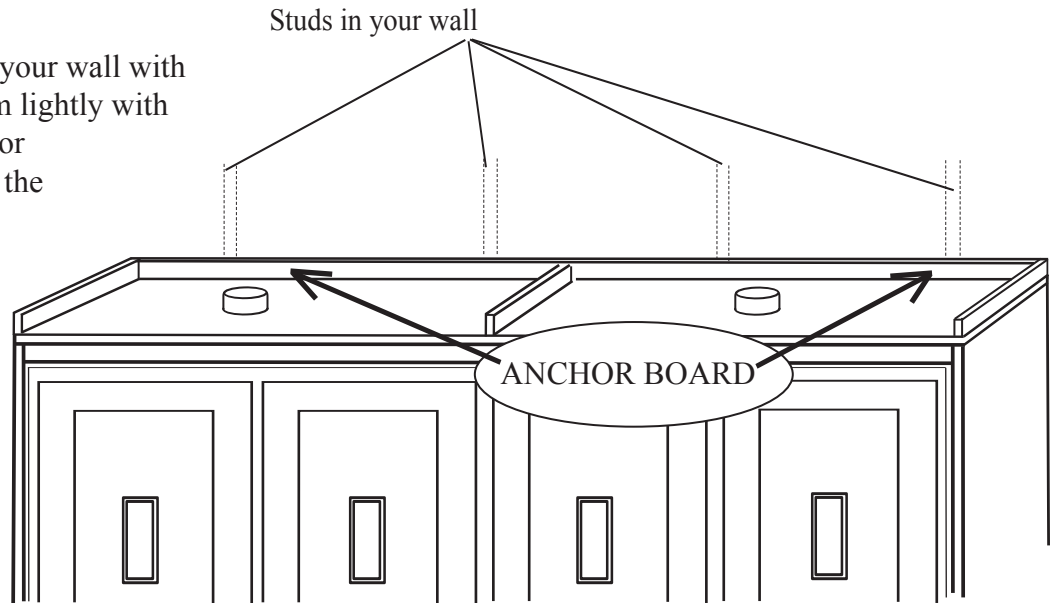

Illustration 7

# WARNING: THE NEXT 2 STEPS MAY REQUIRE PROFESSIONAL

IF YOUR WALLS ARE NOT TRADITIONAL WOOD FRAMING, YOU MAY NEED TO HIRE A HANDY MAN OR CONTRACTOR TO HELP IN ANCHORING THE BED TO YOUR WALL. FAILURE TO PROPERLY ANCHOR CABINET COULD CAUSE SEVERE PERSONAL INJURY. CALL TECHNICAL SUPPORT AT 866-725-6401 IF YOU HAVE ANY QUESTIONS.

Step 14: Locate the studs in your wall with a stud finder, then mark them lightly with a pencil just above the Anchor Board located at the back of the Bridge Board. You should find at least 3 studs for anchoring the bed to the wall.



Step 15: Using a 1/4" drill bit pre-drill holes through the Anchor Board that correspond with the 3 studs in your wall. Now, using three, 3 1/2" screws and decorative washers anchor the Wall Bed to the wall. IT IS EXTREMELY IMPORTANT THAT THE BED IS ANCHORED SECURELY TO THE WALL.

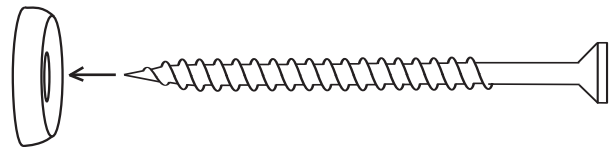

Step:16 Place Bridge Cap on the bridge board. Cap is not designed to be anchored to the bed.

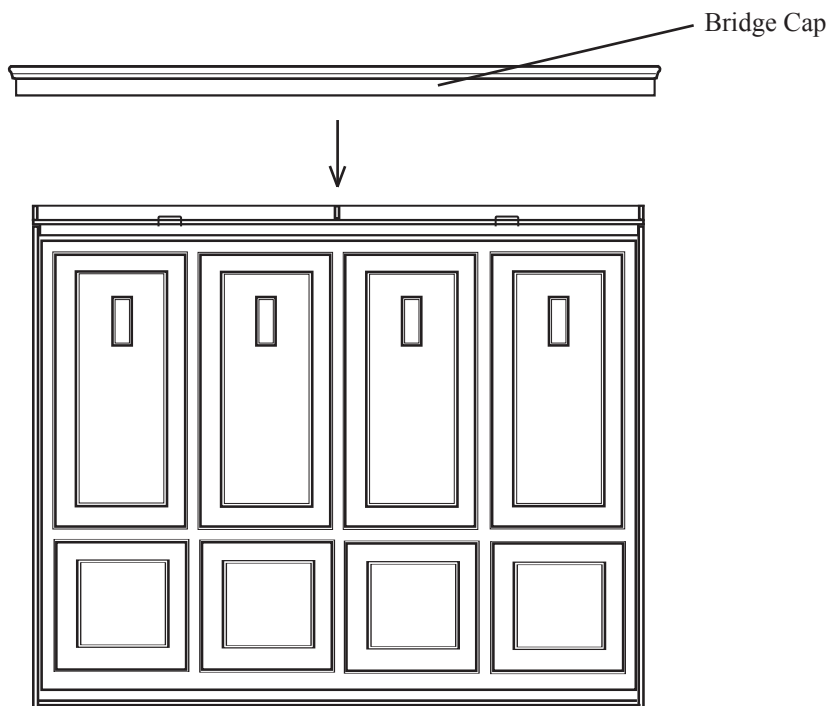

## SIDE CABINETS

NOTE: It is recommended to attach the side cabinets to the bed so they fit tight to the bed and are secured properly.

NOTE: Side cabinets contain their own hardware.

Step 17: Anchor the Side Cabinet to the Bed by first pre-drilling two 3/16" holes at the inside edge of the side cabinet. Position the holes close to the front edge of the side cabinet just behind the Face Frame. One hole should be near the top, the second about 15" from the bottom of the cabinet. (illustration 9)

Step 18: Use three 1 1/4" Gold Screws through pre-drilled holes to anchor Side Cabinets to the Bed's Side Boards. (See illustration 9)

Step 19: Insert Gold Shelf Supports at desired location in Side Cabinets then place adjustable shelves.

